

UNITED STATES DISTRICT COURT
DISTRICT OF DELAWARE

SWISSX LABS AG, INC.,
Plaintiff,

v.

JUUL LABS, INC.
Defendant.

C.A. NO. _____

JURY TRIAL DEMANDED

COMPLAINT FOR PATENT INFRINGEMENT

Plaintiff SwissX Labs AG, Inc., d/b/a SwissX USA (herein, “SwissX” or “Plaintiff”), by and through its undersigned counsel, hereby submits this complaint for patent infringement against Defendant Juul Labs, Inc. (herein, “Juul” or “Defendant”). For its Complaint, SwissX alleges as follows:

THE PARTIES

1. SwissX is a corporation organized under the laws of the state of Delaware, with a principal place of business at 23768 Malibu Rd., Malibu, CA 90265.
2. Juul is a corporation organized under the laws of the state of Delaware, with a principal place of business at 560 20th Street, San Francisco, CA 94107.

JURISDICTION AND VENUE

3. This is an action for infringement of U.S. Patent No. 9,351,522 (the “’522 patent”), titled “Cartomizer e-cigarette,” duly issued by the U.S. Patent and Trademark Office (“USPTO”) on May 31, 2016. A copy of the ’522 patent is attached as Exhibit 1 to this Complaint. The ’522 patent names a sole inventor, Robert Safari.
4. SwissX is the owner, by way of assignment, of all right, title and interest in and to the ’522 patent. A copy of the assignment from Mr. Safari to SwissX, assigning all right, title and interest in and to the ’522 patent to SwissX, is attached as Exhibit 2 to this Complaint. The assignment has been recorded at the USPTO.
5. This court has original jurisdiction over the subject matter of this action

pursuant to 28 U.S.C. §§ 1331 and 1338(a), because SwissX’s claims arise under the patent laws of the United States, 35 U.S.C. §§ 1 *et seq.*

6. This court has general personal jurisdiction over Juul because Juul is incorporated under the laws of Delaware. Because Juul is incorporated in Delaware, it “resides” in Delaware, and is subject to general personal jurisdiction in Delaware.

7. Venue is proper in this district under 28 U.S.C. § 1400(b) because Juul resides in this judicial district. Juul resides in this judicial district because it is incorporated under the laws of the state of Delaware.

THE ASSERTED PATENT

8. The ’522 patent issued from U.S. Patent Application No. 13/629,541 (“the ’541 Application”), which was filed at the USPTO on September 27, 2012. The ’541 Application claimed priority to U.S. Provisional Patent Application No. 61/541,039, which was filed at the USPTO on September 29, 2011.

9. The ’522 patent names a single inventor, Robert Safari. The ’522 patent issued to Mr. Safari in his individual capacity. Mr. Safari retained full ownership of the ’522 patent until he assigned it to SwissX in 2020.

10. The ’522 patent discloses and claims a “cartomizer” for use with an e-cigarette, as well as e-cigarette assemblies using such cartomizers.

11. As the ’522 patent explains, at the time the ’541 Application was filed, most conventional e-cigarettes had three major components: (i) a “cartridge,” which included a mouthpiece and a reservoir to hold e-cigarette liquid; (ii) an “atomizer,” which “serve[d] as the heating element responsible for vaporizing the liquid to provide the aerosol mist;” and (iii) a “battery unit,” which “serve[d] as a battery supply” to power the heating unit and related electronics. Ex. 1, 1:52-57. Other e-cigarettes at the time used “cartomizers,” which “replace[d] the separate cartridge and atomizer components with a single integrated component.” *Id.*, 1:52-56.

12. The ’522 patent discloses and claims novel, nonobvious cartomizer arrangement(s), and novel, nonobvious e-cigarettes using such cartomizers.

13. Independent claim 1 of the '522 patent recites a “cartomizer unit for use in electronic cigarette[s].” The text of claim 1 is reproduced below, with annotations to identify the elements of the claim:

(1pre) 1. A cartomizer unit for use in an electronic cigarette, the cartomizer unit comprising:

(1a) a liquid chamber for receiving a liquid solution, wherein the liquid chamber includes

(1a1) a liquid chamber end cap that is removable for allowing the liquid solution to be received by the liquid chamber and

(1a2) an air intake opening formed therein

(1a3) wherein said air intake opening is covered with a semi-permeable membrane allowing air into the liquid chamber while retaining the liquid solution with the liquid chamber;

(1b) an atomization chamber disposed adjacent to the liquid chamber and separated therefrom by a dividing wall,

(1b1) the dividing wall having a dividing wall opening formed therein;

(1c) at least one atomization chamber vent formed in the atomization chamber for receiving air and expelling a liquid solution aerosol mist; and

(1d) a guiding wick that extends through the dividing wall opening from the liquid chamber to the atomization chamber to supply liquid solution from the liquid chamber to the atomization chamber.

14. In addition to claim 1, the '522 patent has two other independent claims. Independent claim 10 recites an “electronic cigarette” comprising a “cartomizer unit” and a “power unit connected to the cartomizer unit.” Independent claim 15 recites an “electronic cigarette” comprising a “mouthpiece tube,” a “cartomizer unit,” a “first fitting disposed at a second end of the mouthpiece tube,” a “battery unit tube,” a

“battery unit disposed within the battery unit tube,” and a “second fitting disposed at a first end of the battery unit tube,” among other requirements.

15. SwissX has standing to sue for infringement of the ’522 patent because it is the sole assignee of all right, title and interest to the ’522 patent. *See* Ex. 2.

16. The ’522 patent was in full force and effect from the date of its issuance (May 31, 2016) until June 1, 2020. On June 2, 2020, the enforceability of the ’522 patent temporarily lapsed, due to an inadvertent failure to pay the maintenance fee.

17. On December 21, 2020, SwissX filed a Petition to reinstate the ’522 patent at the USPTO. The Petition was granted, and SwissX paid the outstanding fee. *See* Ex. 3 (USPTO record of maintenance fee payment). Thus, on December 21, 2020, the ’522 patent was restored to full force and effect. Under 35 U.S.C. § 284, SwissX is entitled to damages adequate to compensate it for all acts of infringement that occurred, or which may occur, at any point while the ’522 patent was or is in force—*i.e.*, for all periods of time except June 2, 2020 through December 20, 2020.

MARKING

18. From the issue date of the ’522 patent to the present, neither Mr. Safari nor SwissX made, sold, offered for sale, imported, or commercialized any product that practices any claim of the ’522 patent.

19. From the issue date of the ’522 patent to the present, neither Mr. Safari nor SwissX authorized, licensed, or allowed any third party to make, sell, offer for sale, import, or commercialize any product that practices any claim of the ’522 patent.

20. Because the owners of the ’522 patent have not made, sold, offered for sale or imported any product that practices any claim of the ’522 patent—either directly, or through third-party licensees—at any point during the lifetime of the ’522 patent, the marking requirement of 35 U.S.C. § 287(a) does not apply.

21. Accordingly, the marking requirement of 35 U.S.C. § 287(a) does not limit SwissX’s entitlement to damages in this case.

DEFENDANTS’ INFRINGING PRODUCTS

22. Juul is the nationwide leader in e-cigarette sales. Juul earns billions of dollars in annual revenue from sales of its e-cigarette products in the United States. On information and belief, Juul has a 60-70%+ share of the U.S. e-cigarette market.

23. Juul's primary products are: (i) the "Juul Device," which is a portable e-cigarette battery/control unit; and (ii) "JuulPods," which are disposable cartomizers for use with the Juul Device. *See* Ex. 4 (printout of <https://www.juul.com/shop>, accessed on January 12, 2021) at 3.

24. The Juul Device is a long, thin device which contains a battery, a microcontroller, charging contacts for supplying power to the battery, and electrical contacts for supplying power to the heating element of the cartomizers (JuulPods). Top, bottom and side views of the Juul Device are shown below:

Top view:

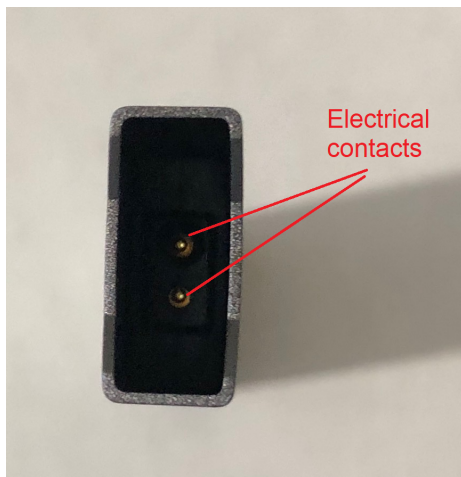

Bottom view:

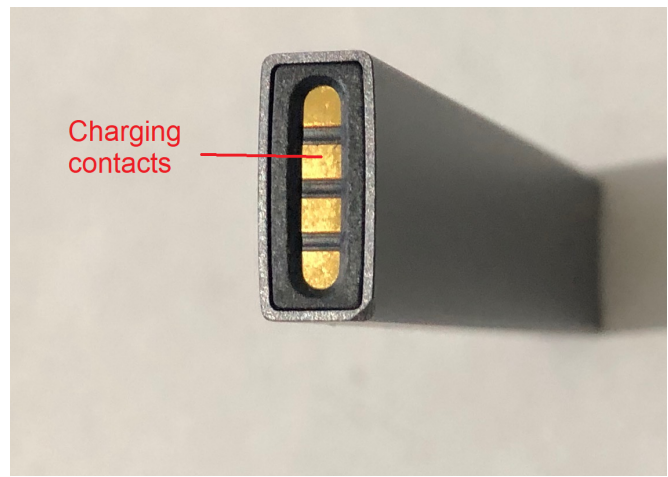

Side view:



25. JuulPods are disposable cartomizers designed to be installed into the top of the Juul Device. Juul sells JuulPods in several flavors, including Menthol and Virginia Tobacco. An assembled JuulPod, containing Virginia Tobacco-flavored e-cigarette liquid, is shown below:

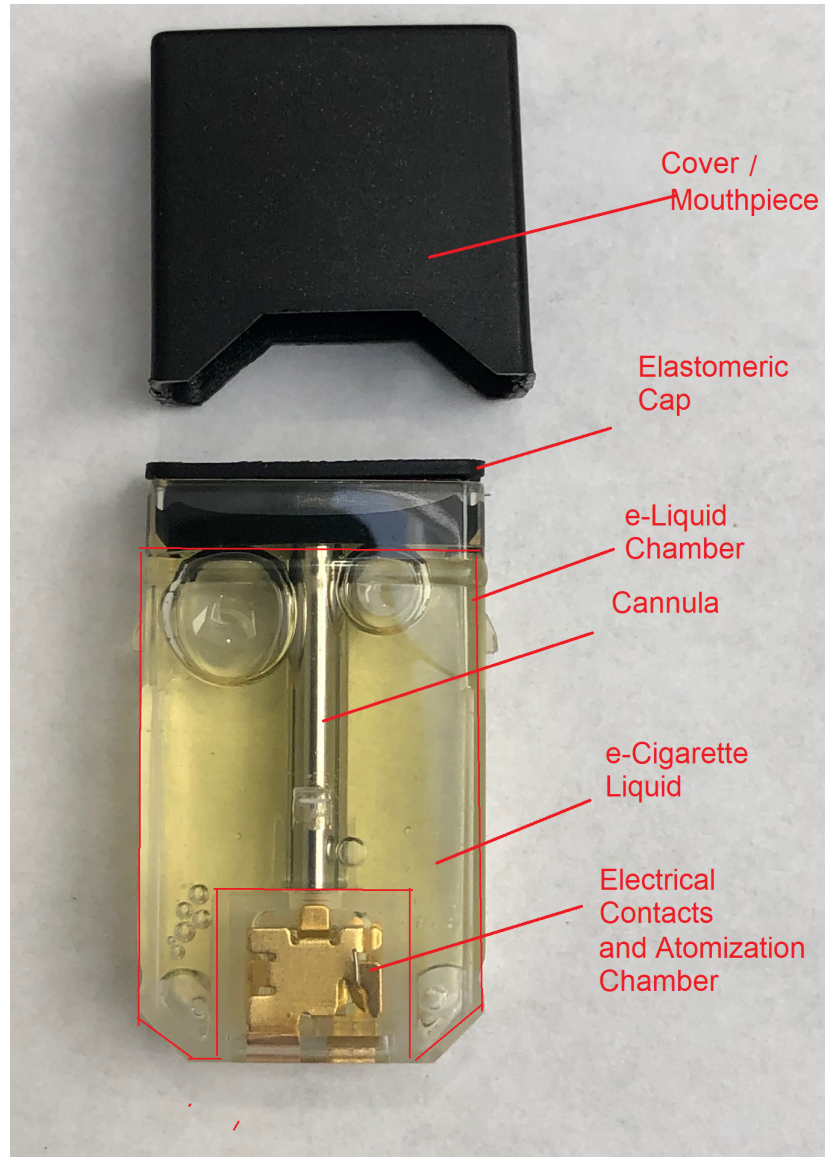

26. As seen above, a JuulPod includes: (i) a removable cover/mouthpiece; (ii) a removable cap, made of an elastomeric material; (iii) an e-liquid chamber (outlined in red); (iv) e-cigarette liquid within the e-liquid chamber; (v) a cannula, or thin cylindrical tube, within the e-liquid chamber; and (vi) electrical contacts at the

bottom of the pod, which contact the electrical contacts within the Juul Device to supply electrical power. Although not visible in the picture above, because it is obscured by the electrical contacts, there is also an atomization chamber in the JuulPod, in which e-cigarette liquid is heated into vapor. During use, the heated vapor passes through the cannula, through a hole in the elastomeric cap, through a hole in the cover/mouthpiece, and into the user's mouth, where it is inhaled.

27. A drained and disassembled JuulPod is shown below:

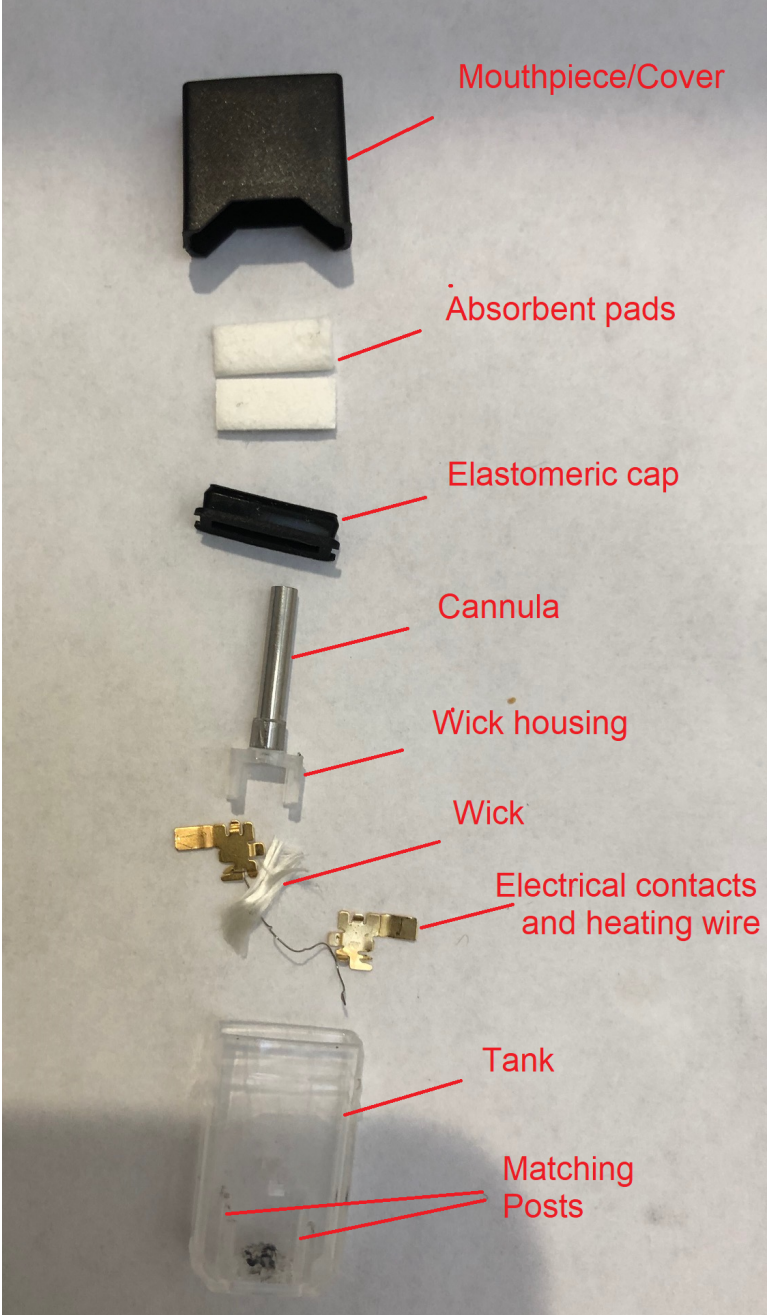

28. In addition to the components already described in Paragraph 26 *supra*, the picture above shows that JuulPods contain: (i) two absorbent pads, which sit inside the mouthpiece/cover, to prevent e-cigarette liquid from flowing through the hole in the elastomeric cap into the user's mouth; (ii) a four-pronged wick housing, which is installed at the base of the cannula, and which (when the Pod is assembled) is connected to four matching posts at the base of the tank to form the atomization chamber; (iii) a wick, which appears to be made from silica fiber; and (iv) a heating wire, which—when the Pod is assembled—is connected to the two electrical contacts, and coiled around the wick, to heat the wick when electrical power is supplied.

29. An oblique view of the wick housing is shown below:



30. As seen above, the two sets of prongs in the wick housing form two arch-shaped holes. When the wick housing is connected to the four matching posts of the JuulPod base (i.e., when the JuulPod is assembled), the arch-shaped holes form a channel, or opening, between the atomization chamber and the e-liquid chamber. This channel is plugged by the wick, which extends from the atomization chamber into both adjacent sides of the e-liquid chamber. This can be seen in the picture below,

which is a bottom view of a partially-disassembled JuulPod:

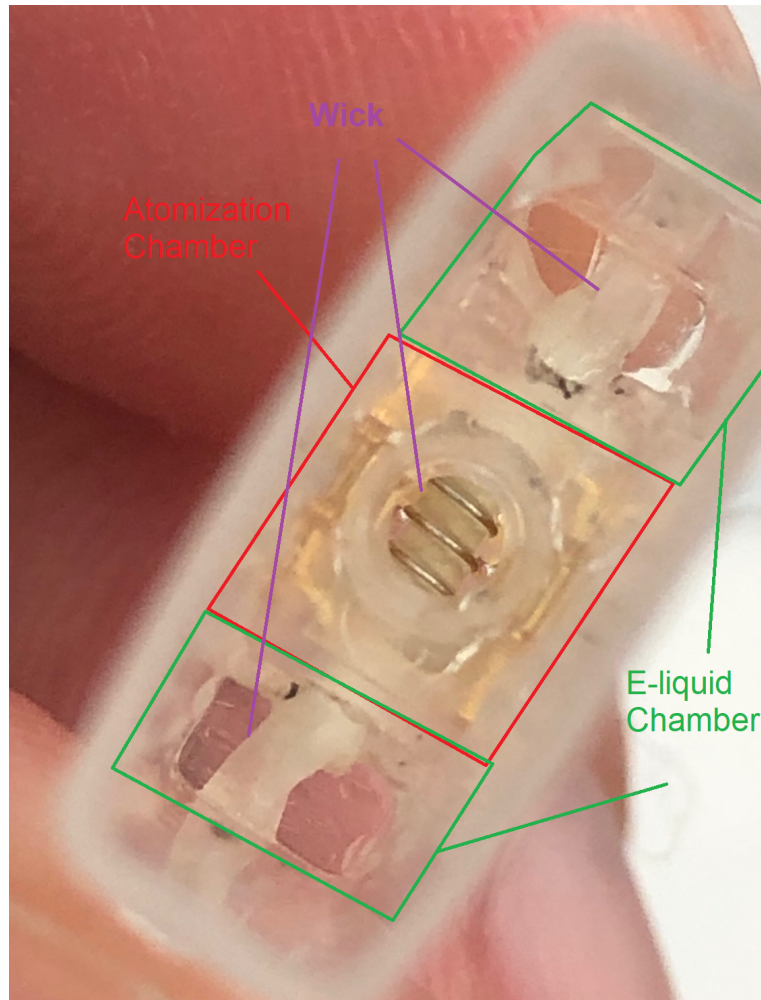

31. As seen above, the wick (with the heating wire coiled around it) extends from the central atomization chamber into both adjacent sides of the e-liquid chamber. During operation, this allows the e-liquid to be drawn from the e-liquid chamber, via capillary action, into the portion of the wick that resides within the atomization chamber, where it is heated and converted into vapor.

32. The wick substantially fills the openings on the two sides of the atomization chamber. Thus, in addition to drawing e-liquid into the portion of the wick that resides in the atomization chamber, the wick also prevents e-liquid from flowing, via fluid flow, into the atomization chamber. This is important because,

otherwise, e-liquid could flow into the chamber and—if the JuulPod is held upside down—through the cannula and out through the mouthpiece, causing leaking.

33. That the wick prevents e-liquid from inadvertently flowing into the atomization chamber is confirmed by Juul’s U.S. Pat. No. 10,058,130 (“the ‘130 patent”), a copy of which is attached as Exhibit 5. Certain embodiments of the ‘130 patent—including the embodiments shown in Figs. 24A-28D and Fig. 30—describe the configuration of the JuulPod as sold. This can be seen by comparing, e.g., Fig. 30 of the ‘130 patent with the disassembled JuulPod shown in Paragraph 27 *supra*:

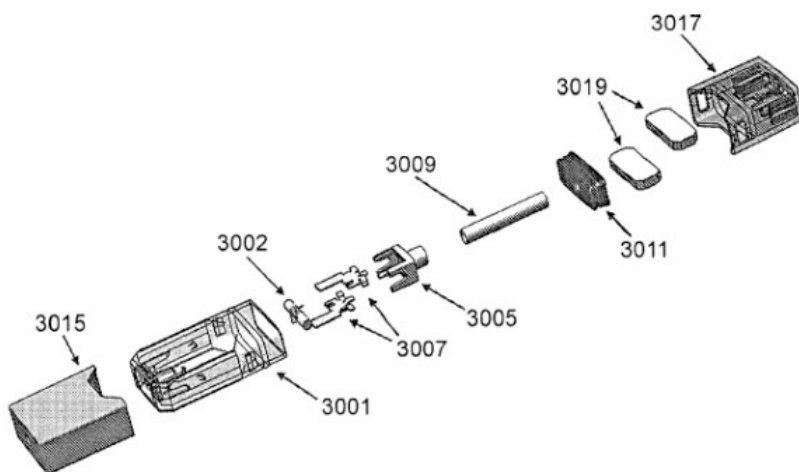

FIG. 30

34. As seen above, Fig. 30 of the ‘130 patent corresponds almost exactly to the JuulPod as sold. Figs 24A-28D of the ‘130 patent also correspond to the JuulPod as sold. Thus, the ‘130 patent’s description of, at least, the Fig. 24A-28D and 30 embodiments describes the structure and arrangement of the JuulPod as sold.

35. This is further confirmed by Juul’s patent marking. Juul’s website, at <https://www.juul.com/intellectual-property-list>, lists a number of patents that cover the “JuulPods.” Those patents include “US10058130,” i.e., the ‘130 patent. This confirms that the ‘130 patent’s description of, at least, the embodiments of Figs. 24A-28D and 30 describes the JuulPods as sold.

36. The ‘130 patent states the following about the “wick” of Fig. 30:

The wick is porous and provides a capillary pathway for fluid within the tank through and into the wick; the capillary pathway is generally large enough to permit wicking of sufficient material to replace vaporized liquid transferred from the tank by capillary action (wicking) during use of the electronic cigarette, ***but may be small enough to prevent leakage of the vaporizable fluid material out of the cartridge during normal operation, including when applying pressure (e.g., squeezing) the cartridge.*** The external portion of the wick may include a wick housing 3005. ***The wick housing and/or wick may be treated to prevent leakage.***

Ex. 5, 49:46-65. This confirms that, in addition to drawing e-liquid into the atomization chamber for evaporation, the wick serves the function of ensuring that e-liquid does not leak out of the JuulPod.

37. A bottom view of a fully-assembled JuulPod is shown below:

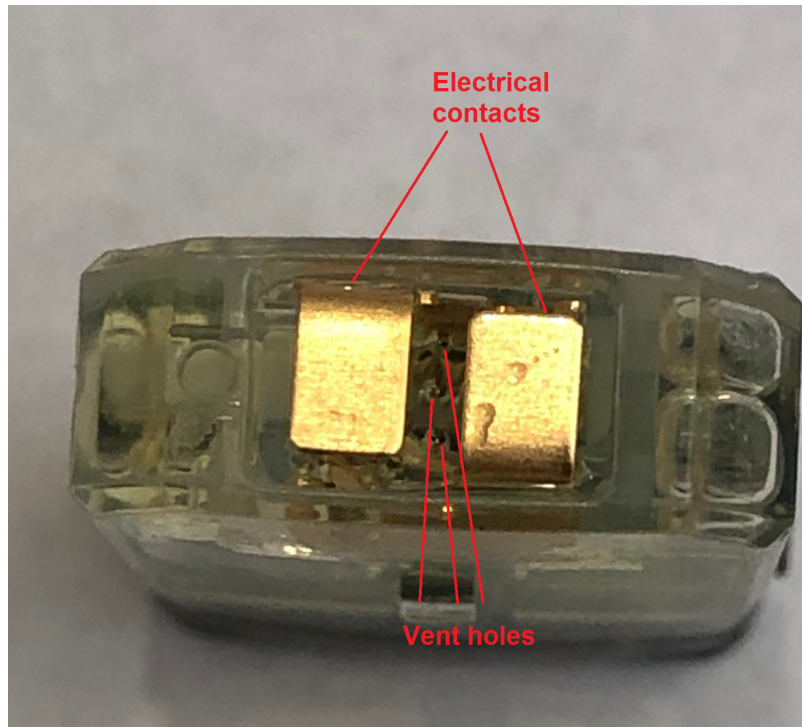

38. As seen above, between the electrical contacts at the base of the JuulPod, there is a membrane with three small vent holes. On information and belief, the purpose of these vent holes is to permit air to travel through the base of the

JuulPod into the Juul Device, so that a pressure sensor within the Juul Device can sense a user's inhalation, and trigger the heating coil. The membrane in which the vent holes are located ensures that e-liquid does not leak into the Juul Device.

39. In operation, a JuulPod is installed into the matching opening at the top of the Juul Device. When a user inhales through the mouthpiece, an airflow channel is created through the mouthpiece hole, through the hole in the elastomeric cap, through the tank (via the cannula), through the vent holes in the JuulPod base, and into the Juul Device. The pressure sensor in the Juul Device senses the pressure change caused by the user's inhalation and, in response, supplies power from the battery to the heating wire. The heating wire vaporizes e-cigarette liquid in the wick, which flows through the cannula, into the mouthpiece, and into the user's mouth. As the e-cigarette liquid in the wick is depleted, capillary action draws further e-cigarette liquid from the liquid chamber into the portion of the wick residing within the atomization chamber. This process continues until the JuulPod is depleted, at which point it is either refilled, or the user may install a new JuulPod.

DEMONSTRATION OF INFRINGEMENT

40. The JuulPod, as outlined above, satisfies each and every element of, at least, claim 1 of the '522 patent. This is demonstrated below on an element-by-element basis, with elements identified by the annotations in Paragraph 13 *supra*.

41. **As for element (1pre):** The JuulPod is a “cartomizer unit for use in an electronic cigarette.” As discussed above, a “cartomizer” is an assembly that includes both a liquid reservoir of e-cigarette liquid and an atomizing unit. The JuulPod includes a liquid reservoir of e-cigarette liquid: i.e., the “e-liquid chamber” shown in Paragraph 25 *supra*. It also includes an atomizing unit—i.e., the loop of wire coiled around the wick, as shown in Paragraph 30 *supra*. Moreover, the JuulPod is specifically designed for use “with an electronic cigarette,” i.e., the Juul Device. Thus, the JuulPod literally satisfies element (1pre).

42. **As for element (1a):** The JuulPod includes a “liquid chamber for

receiving a liquid solution,” i.e., the e-liquid chamber shown in Paragraphs 25-26 *supra*. Thus, the JuulPod literally satisfies element (1a).

43. **As for element (1a1):** The JuulPod has a “liquid chamber end cap that is removable for allowing the liquid solution to be received by the liquid chamber,” i.e., the removable elastomeric cap. The elastomeric cap can be removed to allow liquid into the chamber. Thus, the JuulPod literally satisfies element (1a1).

44. **As for element (1a2):** The liquid chamber in the JuulPod has multiple “air intake openings.” These include: (i) the two openings in the atomization chamber, which are substantially plugged by the wick, as shown and described in Paragraphs 29-32 *supra*; and (ii) the hole in the base of the JuulPod, covered by a membrane with three small vent holes, as shown and described in Paragraphs 37-38 *supra*. Thus, the JuulPod literally satisfies element (1a2), as it has multiple “air intake openings.”

45. **As for element (1a3):** The “air intake openings” identified in Paragraph 44 *supra* are each “covered with a semi-permeable membrane allowing air into the liquid chamber while retaining the liquid solution with[in] the liquid chamber,” i.e.:

a. The two openings in the atomization chamber are “covered with a semi-permeable membrane,” i.e., the wick. As shown in Paragraph 36 *supra*, the “capillary pathway” of the wick is specifically designed to be “small enough to prevent leakage of the vaporizable fluid material out of the cartridge during normal operation.” Ex. 5, 49:46-65. Thus, the wick is a “semi-permeable membrane” which “retain[s] the liquid solution with[in] the liquid chamber.” Because the capillary pathway of the wick is large enough to permit some liquid to flow, it is also clearly large enough to permit air to flow. Thus, the wick also “allow[s] air into the liquid chamber.” Accordingly, the combination of the two openings in the atomization chamber and the wick, which fills those openings, literally satisfies element (1a3).

b. The base of the JuulPod has a hole covered by a “semi-permeable membrane,” i.e., the membrane containing the three small vent holes, as shown

and discussed in Paragraphs 37-38 *supra*. That membrane retains liquid, and prevents it from flowing into the Juul Device, as discussed in Paragraphs 37-38. That membrane also allows air to flow into the liquid chamber, through the three small vent holes, as discussed in Paragraphs 37-38. Thus, the combination of the hole in the base of the JuulPod, and the membrane with three small vent holes that covers it, literally satisfies element (1a3).

46. **As for element (1b):** The JuulPod includes an “atomization chamber,” i.e., the chamber containing the portion of the wick with the coil wrapped around it, as shown and discussed in Paragraphs 30-31 *supra*. The atomization chamber is “adjacent to” the liquid chamber—i.e., the e-liquid chamber—as shown in Paragraphs 25-26 and 30-31 *supra*. And there is a “dividing wall” separating the atomization chamber from the e-liquid chamber—i.e., the wall formed by the connection between the prongs of the wick housing and the matching posts in the JuulPod base. Thus, the JuulPod literally satisfies element (1b).

47. **As for element (1b1),** the “dividing wall”—i.e., the wall formed by the connection between the prongs of the wick housing and the posts in the JuulPod base—has a “dividing wall opening,” i.e., the opening formed by the arch-shaped recesses in the prongs of the wick housing, as shown in Paragraphs 29-32 *supra*. Thus, the JuulPod literally satisfies element (1b1).

48. **As for element (1c),** the atomization chamber in the JuulPod has an “atomization chamber vent . . . for receiving air and expelling a liquid solution aerosol mist,” i.e., the cannula described in Paragraphs 25-26 and 39 *supra*. Thus, the JuulPod literally satisfies element (1c).

49. **As for element (1d),** in the JuulPod, the “guiding wick . . . extends through the dividing wall opening,” i.e., through the openings formed by the arch-shaped recesses in the wick housing prongs, as shown in Paragraphs 29-32 *supra*. The wick “suppl[es] liquid solution from the liquid chamber to the atomization chamber” by capillary action, as discussed in Paragraphs 31, 36 and 39 *supra*. Thus, the JuulPod

literally satisfies element (1d).

50. Accordingly, for at least the foregoing reasons, the JuulPod literally satisfies each element of claim 1 of the '522 patent. By making, selling, using, offering for sale and/or importing JuulPods in the United States, Juul directly infringes claim 1 of the '522 patent, in violation of 35 U.S.C. § 271(a).

51. Additionally, the combination of a JuulPod and a Juul Device infringes, at least, claim 10 of the '522 patent.

52. Claim 10 of the '522 patent recites an “electronic cigarette” comprising: (i) a “cartomizer unit comprising” various components; and (ii) a “power unit connected to the cartomizer unit.” The components of the “cartomizer unit” in claim 10 are essentially identical to the components of the “cartomizer unit” of claim 1, except that claim 10’s “cartomizer unit” does not require an “atomization chamber vent,” whereas claim 1’s cartomizer unit does require such a vent.

53. As shown in Paragraphs 41-49 *supra*, a JuulPod satisfies all the elements of claim 1. Thus, *a fortiori*, it satisfies all the elements of the “cartomizer unit” of claim 10, because claim 10 has *fewer* requirements for the cartomizer than claim 1.

54. A JuulPod does not include a “power unit connected to the cartomizer unit,” as required by claim 10. However, the Juul Device does include a “power unit,” i.e., the battery within the Juul Device. JuulPods are specifically designed to be plugged into the electrical contacts of the Juul Device (as shown in Paragraph 24 *supra*), at which point the battery in the Juul Device (the “power unit”) supplies power to heat the wire in the JuulPod when a user’s inhalation is detected.

55. Accordingly, the assembly of a JuulPod and a Juul Device satisfies claim 10, because it includes both: (i) the recited “cartomizer unit,” with all components thereof; and (ii) a “power unit connected to the cartomizer unit,” i.e., the battery unit within the Juul Device, which is electrically connected to the JuulPod.

56. On information and belief, Juul sells Juul “starter packs,” which are packages that contain **both** a Juul Device and a number of Juul Pods. On information

and belief, such “starter packs” come with instructions specifically directing users to install the JuulPods into the Juul Device. Accordingly, a Juul “starter pack” includes all components necessary to practice claim 10 of the ’522 patent, and specifically instructs end-users to combine the components to practice claim 10. Accordingly, sales of Juul starter packs directly infringe claim 10 of the ’522 patent.

57. On information and belief, JuulPods and the Juul Device also directly infringe other claims of the ’522 patent. SwissX reserves the right to identify additional claims of the ’522 patent that are directly infringed at the appropriate time, such as in SwissX’s Initial Infringement Disclosures.

JUUL’S KNOWLEDGE OF THE ’522 PATENT

58. Juul has known about the ’522 patent since, at the latest, March 4, 2018. This is confirmed by the fact that, on March 4, 2018, Juul filed an Information Disclosure Statement (IDS) at the USPTO in prosecution of the application that issued as the ’130 patent. A copy of this IDS is attached as Exhibit 6. In the IDS, Juul specifically advised the USPTO that the ’522 patent might be relevant prior art to the ’130 patent. *See* Ex. 6 at 34. Thus, Juul knew of the existence and relevance of the ’522 patent to its JuulPods and Juul Devices by, at the latest, March 4, 2018.

59. In fact, the ’522 patent is listed as a reference cited in ***24 separate*** Juul issued patents. This is shown by Exhibit 7, a printout from the USPTO website, showing all Juul patents in which the ’522 patent has been cited as a prior art reference. Because the ’522 patent was cited as a prior art reference in ***24 separate*** Juul patents, Juul clearly knew of the existence and relevance of the ’522 patent to its JuulPods and Juul Devices prior to the filing of the instant Complaint.

60. On information and belief, from at least March 4, 2018 to the present, Juul sold JuulPods and Juul Devices despite knowing that those products infringed the ’522 patent, being willfully blind that those products infringed the ’522 patent, and/or knowing there was an objectively high risk those products infringed the ’522 patent.

COUNT I – DIRECT PATENT INFRINGEMENT (35 U.S.C. § 271(a))

61. SwissX repeats and realleges each and every allegation contained in Paragraphs 1-60 *supra* as if fully set forth herein.

62. Juul has directly infringed at least claim 1 of the '522 patent by making, selling, using, offering for sale and/or importing JuulPods in the United States, after the issue date of the '522 patent. As shown in Paragraphs 41-49 *supra*, JuulPods literally satisfy all the elements of claim 1 of the '522 patent. Thus, all sales, uses, offers for sale, manufacture, or importation of JuulPods in the United States directly infringe, at least, claim 1 of the '522 patent.

63. After the issue date of the '522 patent, Juul has made, sold, offered for sale, used and imported JuulPods in the United States. Accordingly, Juul has directly infringed, at least, claim 1 of the '522 patent, in violation of 35 U.S.C. § 271(a).

64. As shown in Paragraphs 51-56 *supra*, the combination of a JuulPod and a Juul Device satisfies all the elements of claim 10 of the '522 patent. When Juul sells a Juul Starter Kit, which includes JuulPods, a Juul Device, and instructions on how to install the JuulPods into the Juul Device, it sells all the components necessary to practice claim 10, and specifically directs its customers to combine the components to practice claim 10. By including all of the necessary components, with instructions, in a single package, Juul's Starter Kits directly infringe claim 10 of the '522 patent. Thus, Juul has directly infringed claim 10 by making, selling, offering for sale, using and/or importing Juul Starter Kits in the U.S. after the issue date of the '522 patent.

65. On information and belief, Juul has directly made and used combined JuulPod-Juul Device assemblies in the United States, e.g., for testing and marketing purposes. Each time Juul made or used a combined JuulPod-Juul Device assembly in the United States, it directly infringed claim 10 of the '522 patent. Thus, for this additional reason, Juul has directly infringed claim 10 of the '522 patent.

66. On information and belief, Juul's selling, offering for sale, manufacture, use and/or importation of JuulPods and Juul Devices in the United States has also directly infringed other claims of the '522 patent. SwissX reserves the right to identify

such other claims at the appropriate time, such as in Initial Infringement Disclosures.

COUNT II – INDUCEMENT OF INFRINGEMENT (35 U.S.C. § 271(b))

67. SwissX repeats and realleges each and every allegation contained in Paragraphs 1-66 *supra*, as if fully set forth herein.

68. Juul has actively induced infringement of, at least, claim 10 of the '522 patent, in violation of 35 U.S.C. § 271(b).

69. Juul has actively induced infringement of, at least, claim 10 of the '522 patent, by selling JuulPods and Juul Devices, along with instructions specifically directing customers to install the JuulPods into the Juul Devices. As shown in Paragraphs 51-56 *supra*, when a JuulPod is installed into a Juul Device, the resulting assembly satisfies all the elements of claim 10 of the '522 patent. Thus, when a user installs a JuulPod into a Juul Device, the user “makes” an assembly that directly infringes claim 10. Similarly, when a user uses a combined JuulPod-Juul Device assembly, it “uses” the assembly, which directly infringes claim 10.

70. Juul specifically instructs its customers on how to combine the JuulPods and Juul Devices to “make” the assembly that directly infringes claim 10, and on how to “use” the combined assembly in an infringing manner. For example, the product instructions enclosed with the Juul Device include the following:

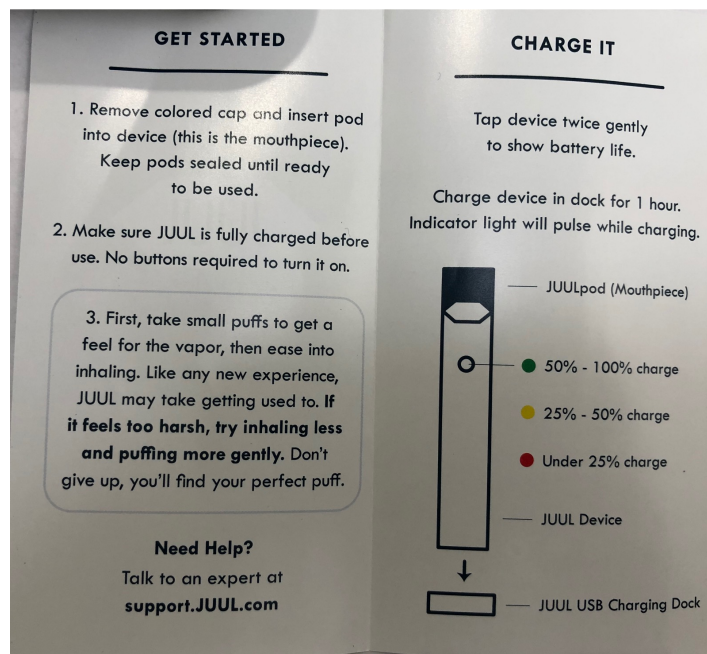

71. As seen above, the instructions for a Juul Device specifically instruct users to “insert [Juul] pod[s] into device.” The instructions also specifically show users where to insert the JuulPods. And the instructions specifically instruct users on how to use the device, e.g., to “take small puffs to get a feel for the vapor.” Thus, Juul specifically instructs its users on how to: (i) make the infringing JuulPod-Juul Device assembly; and (ii) use the infringing JuulPod-Juul Device assembly.

72. Accordingly, Juul has taken active steps—including selling JuulPods, selling Juul Devices, and providing instructions on how to make and use the infringing JuulPod–Juul Device assembly—to induce its users to directly infringe claim 10 of the ’522 patent. Juul’s users actually do directly infringe claim 10 of the ’522 patent, by making and using the combined JuulPod-Juul Device assembly.

73. As shown in Paragraphs 58-60 *supra*, Juul was aware of the existence and relevance of the ’522 patent when it performed the acts of inducement identified in Paragraph 72 *supra*. For the reasons set forth in Paragraphs 58-60, and on information and belief, Juul performed those acts despite knowing, or being willfully blind, that the induced acts constitute direct infringement of claim 10.

74. Accordingly, Defendants have unlawfully induced infringement of, at least, claim 10 of the ’522 patent, in violation of 35 U.S.C. § 271(b).

COUNT III - CONTRIBUTORY INFRINGEMENT (35 U.S.C. § 271(c))

75. SwissX repeats and realleges each and every allegation in Paragraphs 1-74 *supra* as if fully set forth herein.

76. Juul has unlawfully contributed to infringement of, at least, claim 10 of the ’522 patent in violation of 35 U.S.C. § 271(c).

77. As discussed above, the combined JuulPod-Juul Device assembly satisfies all the elements of, at least, claim 10 of the ’522 patent. Thus, when a Juul customer assembles the JuulPod-Juul Device assembly, they directly infringe claim 10 by “making” an infringing assembly. Similarly, when customers use the combined

assembly, they directly infringe claim 10 by “using” an infringing assembly.

78. The JuulPods and Juul Device each constitute a material part of the invention claimed in claim 10 of the ’522 patent. The JuulPods comprise the “cartomizer unit” recited in claim 10 of the ’522 patent. The Juul Device includes the “power unit” recited in claim 10 of the ’522 patent.

79. The JuulPods and Juul Device are each especially made or adapted for use in an infringement of claim 10 of the ’522 patent. The JuulPods and Juul Device are specifically designed to work together to create the assembly that infringes claim 10. The JuulPod is specifically designed to be a “cartomizer unit,” as recited in claim 10. And the Juul Device is specifically designed to include a “power unit,” as recited in claim 10. Thus, the JuulPods and Juul Device are both especially made and adapted for use in an infringement of claim 10.

80. The JuulPods and Juul Device have no substantial noninfringing uses, and are not staple articles of commerce. The JuulPods are specifically designed to be, and are, cartomizers, designed to be combined with the Juul Device to create a working e-cigarette assembly. Similarly, the Juul Device is specifically designed to be, and is, a base unit that is designed to be used with the Juul Pods to create a working e-cigarette assembly. The Juul Device and JuulPods have no substantial uses other than to create an e-cigarette assembly, as recited in claim 10 of the ’522 patent. Thus, the Juul Device and JuulPods have no substantial noninfringing uses.

81. For the reasons set forth in Paragraphs 58-60 *supra*, and on information and belief, Juul knew of the ’522 patent, and knew that the Juul Devices and JuulPods were especially made to infringe, at least, claim 10 of that patent, when it made, sold, used, offered for sale and imported Juul Devices and JuulPods in the United States.

82. Accordingly, for the foregoing reasons, Juul has unlawfully contributed to infringement of at least claim 10, in violation of 35 U.S.C. § 287(c).

REMEDIES, ENHANCED DAMAGES, EXCEPTIONAL CASE

83. SwissX repeats and realleges each and every allegation in Paragraphs 1-

82 *supra* as if fully set forth herein.

84. Juul's direct infringement (Count I), induced infringement (Count II), and contributory infringement (Count III) of the '522 patent has caused, and will continue to cause, significant damage to SwissX. As a result, SwissX is entitled to an award of damages adequate to compensate it for Juul's infringement, but in no event less than a reasonable royalty pursuant to 35 U.S.C. § 284. SwissX is also entitled to recover prejudgment interest, post-judgment interest, and costs.

85. For at least the reasons set forth in Paragraphs 58-60 *supra*, prior to the filing of this Complaint, Juul knew, was willfully blind, or ignored a known high risk that the JuulPods and Juul Device infringed the '522 patent. Despite this known high risk that its actions constituted direct and indirect infringement, Juul continued to directly and indirectly infringe the '522 patent, up to the filing of this Complaint. Accordingly, Juul's infringement has been (and continues to be) willful.

86. Moreover, unless enjoined, Juul's continued infringement of the '522 patent will cause irreparable harm to SwissX. SwissX has the ability to enter the U.S. market with e-Cigarette or vaping products that practice claims of the '522 patent. As the owner of the '522 patent, SwissX should enjoy the exclusive right to practice the '522 patent within the United States. Yet, Juul has practiced, and continues to practice, the '522 patent within the United States on a massive scale. Unless Juul is enjoined from future infringement of the '522 patent, SwissX will be irreparably harmed, because it will lose the exclusive right to practice the '522 patent that it acquired when it obtained the '522 patent from Mr. Safari.

87. Legal remedies are inadequate to compensate SwissX for the harm from Juul's ongoing infringement. It will be difficult to measure the extent to which SwissX has been harmed by the loss of its exclusive right to practice the '522 patent within the United States. Thus, an injunction is necessary, because legal remedies are inadequate to compensate SwissX for the harm of Juul's infringement.

88. Considering the balance of hardships between Juul and SwissX, an

injunction is warranted. Juul, a billion dollar company, has far greater ability to absorb the effects of an injunction (e.g., by shifting into new product areas, or by redesigning its product not to infringe the '522 patent) than SwissX, a small company.

89. On information and belief, the public interest would not be disserved by a permanent injunction against Juul's continued infringement of the '522 patent.

90. Accordingly, for the foregoing reasons, the Court should enter a permanent injunction, enjoining any further infringement of the '522 patent.

91. For at least the foregoing reasons, including Juul's willful and egregious infringement, the court should enhance damages by up to three times the amount of actual damages awarded under 35 U.S.C. § 284.

92. For at least the foregoing reasons, this case is an "exceptional" case within the meaning of 35 U.S.C. § 285. Accordingly, SwissX is entitled to an award of attorneys' fees and costs, and the Court should award such fees and costs.

PRAYER FOR RELIEF

WHEREFORE, SwissX prays for relief as follows:

1. That judgment be entered in favor of SwissX, and against Juul;
2. That SwissX be awarded damages adequate to compensate it for Juul's infringement of the '522 patent, in an amount to be determined at trial, as well as interest thereon;
3. That the court enter a permanent injunction, enjoining any further acts of infringement of the '522 patent by Juul;
4. That SwissX be awarded the costs of suit;
5. That SwissX's infringement be declared willful and egregious;
6. That the Court increase SwissX's damages up to three times the amount assessed under 35 U.S.C. § 284;
7. That the Court declare this an exceptional case under 35 U.S.C. § 285, and award SwissX its attorneys' fees and costs incurred in this action; and
8. That the Court grant such further relief as it deems just and proper.

JURY TRIAL DEMAND

SwissX demands a jury trial on all issues so triable.

Dated: January 22, 2021 Respectfully submitted,

STAMOULIS & WEINBLATT LLC

/s/ Stamatios Stamoulis

Stamatios Stamoulis (#4606)
800 N. West Street, Third Floor
Wilmington, DE 19801
Telephone: (302) 999-1540
Facsimile: (302) 762-1688
stamoulis@swdelaw.com

LAWRENCE M. HADLEY (pro hac anticipated)
ROBERT E. ALLEN (pro hac anticipated)
STEPHEN E. UNDERWOOD (pro hac anticipated)
GLASER WEIL FINK HOWARD
AVCHEN & SHAPIRO LLP
10250 Constellation Boulevard, 19th Floor
Los Angeles, California 90067
Telephone: (310) 553-3000
Facsimile: (310) 556-2920
lhadley@glaserweil.com
rallen@glaserweil.com
sunderwood@glaserweil.com

Attorneys for Plaintiff
SwissX Labs AG, Inc.